

This manual is for reference and historical purposes, all rights reserved.

This page is copyright© by M. Butkus, NJ.

This page may not be sold or distributed without the expressed permission of the producer

I have no connection with any camera company

On-line camera manual library

This is the full text and images from the manual. This may take 3 full minutes for the PDF file to download.

If you find this manual useful, how about a donation of \$3 to: M. Butkus, 29 Lake Ave., High Bridge, NJ 08829-1701 and send your e-mail address so I can thank you. Most other places would charge you \$7.50 for a electronic copy or \$18.00 for a hard to read Xerox copy.

This will allow me to continue to buy new manuals and pay their shipping costs.

It'll make you feel better, won't it?

**If you use Pay Pal or wish to use your credit card,
click on the secure site on my main page.**

Canon Snappy 50/20



English Edition

INSTRUCTIONS

NOMENCLATURE

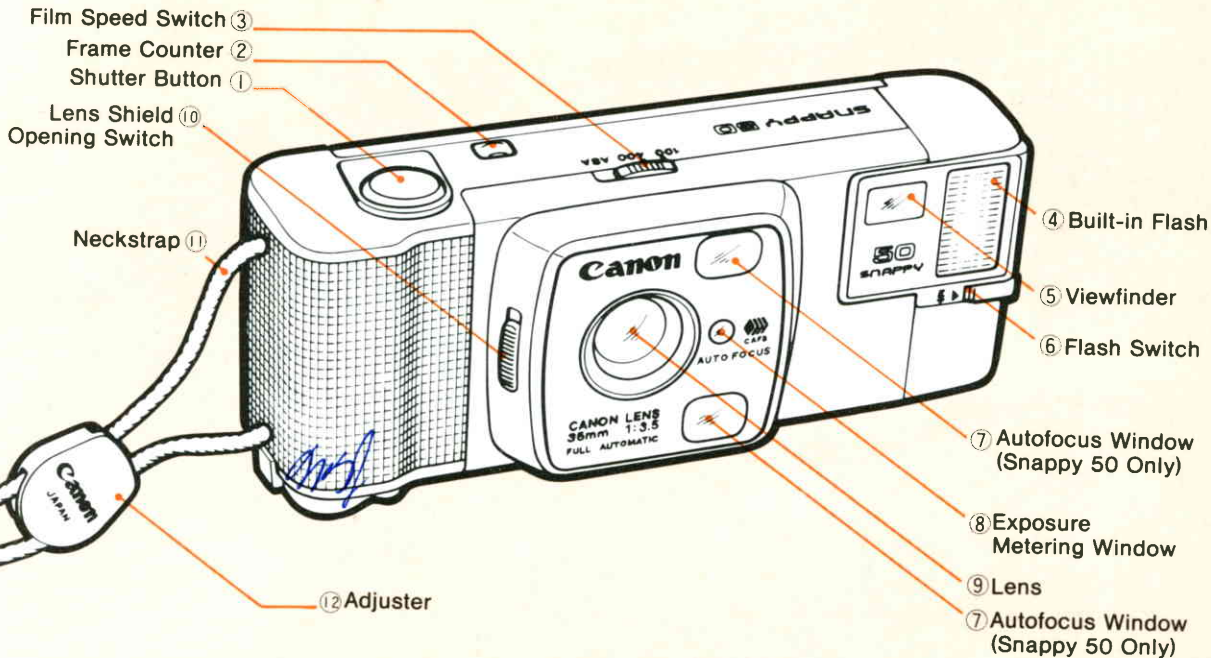

NOMENCLATURE

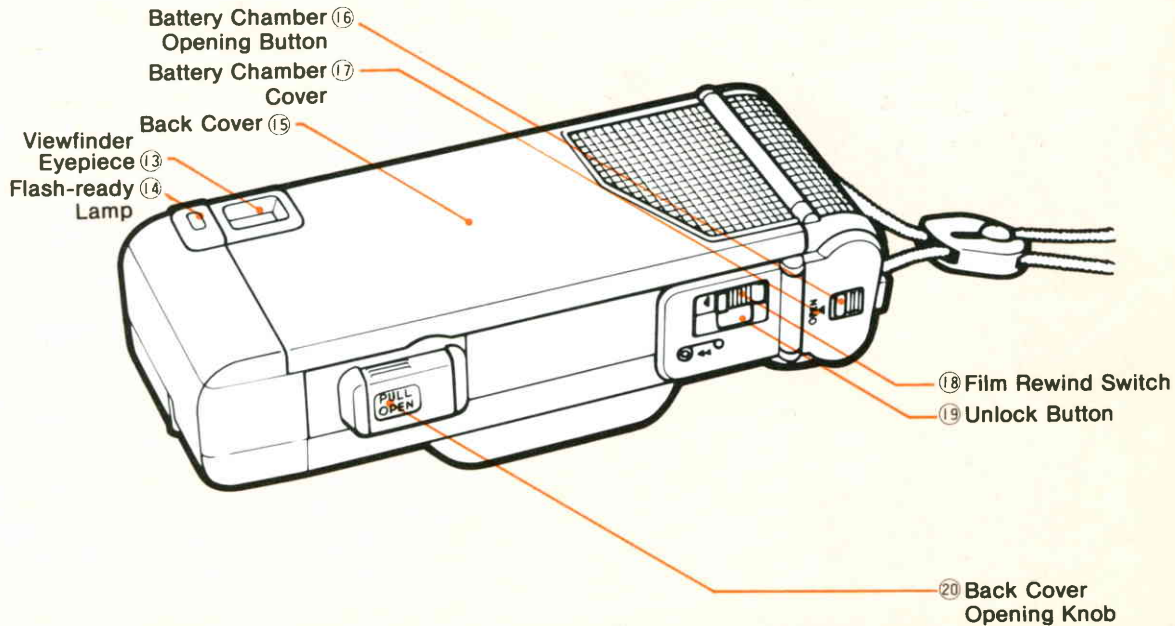

Contents

BASIC OPERATION	6
1. Loading the Batteries	7
2. Opening the Lens Shield	8
3. Checking the Batteries	8
4. Setting the ISO/ASA Film Speed	9
5. Loading the Film	10
6. Shooting	12
7. Shooting Distance	14
8. Using the Built-in Flash	15
9. Flash Shooting Distance Range	17
10. Rewinding the Film	18
● Neckstrap	19
● Care of the Camera	19
SPECIFICATIONS	20

BASIC OPERATION

- 1. Load the batteries.**

- 2. Open the lens shield.**

- 3. Check the batteries.**

- 4. Set the ISO/ASA film speed.**

- 5. Load the film.**

- 6. Look into the viewfinder. Compose the picture so that your subject is centered in the viewfinder.**

- 7. Press the shutter button halfway. If the red viewfinder lamp blinks rapidly, switch to flash and wait for the flash-ready lamp to light up.**

- 8. Press the shutter button all the way to take the picture.**

- 9. At the end of the roll, rewind the film.**



Loading the Batteries

These cameras will not work without batteries. Use two new size-AA 1.5V batteries of the same brand. We recommend using alkaline (LR6) batteries. Carbon-zinc batteries can also be used, but their life is shorter. DO NOT use Ni-Cd batteries.

1. Wipe the battery terminals with a clean, dry cloth to ensure proper contact.
2. Push the battery chamber button  in the direction of the arrow and open the cover.
3. Load the batteries, making sure to place them in the correct $+$ $-$ order indicated on the diagram inside the battery chamber.
4. Snap the cover shut.

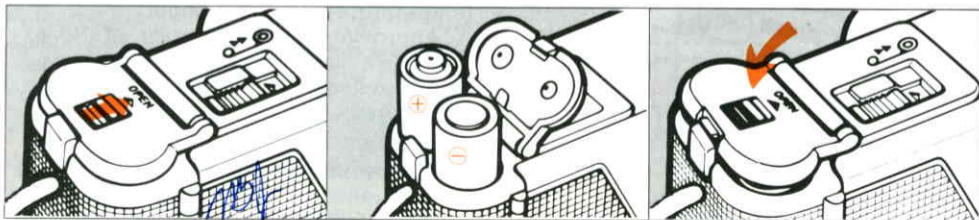

Opening the Lens Shield

To open the lens shield, push the lens shield opening switch ⑩ down. When the lens shield is closed, it is impossible to shoot. This function prevents taking pictures with the lens shield closed.



Checking the Batteries

Check the batteries before using the camera.

1. Cover the lens area of the camera with your hand and press the shutter button ① halfway while looking through the viewfinder.
2. If the viewfinder lamp blinks rapidly, battery power is sufficient.
3. If the viewfinder lamp does not blink, replace both batteries with new ones.

Using new alkaline batteries at normal temperatures, you can shoot:

1. Approximately thirty rolls of 36-exposure film without flash; or
 2. Approximately five rolls of 36-exposure film using flash for each exposure.
-
- Replace the batteries when auto film advance and flash recycling become slower or stop completely.

- Battery power is reduced in very low temperatures (0°C or 32°F), making regular photography difficult. If you plan to take pictures in cold conditions, keep the camera warm until just before you shoot. It is a good idea to carry spare batteries; keep them warm also until they are needed. Don't throw away batteries that have become temporarily unusable because of cold weather. Once they have been restored to room temperature, you may be able to use them again.
- If you don't expect to use the camera for about three weeks or longer, remove the batteries so that they don't leak and corrode the camera's electrical contacts.



Viewfinder Lamp

4 Setting the ISO/ASA Film Speed

For correct exposure, set the ISO/ASA film speed switch ③ according to the ISO/ASA film speed indicated on the film's cartridge and box. Press the ISO/ASA film speed switch ③ and align the white dot with the ISO/ASA 100 or 400 mark.

Notes

1. Please use film with an ISO/ASA 100 or ISO/ASA 400 rating.
2. Reset the film speed switch each time you load film with a different ISO/ASA rating.

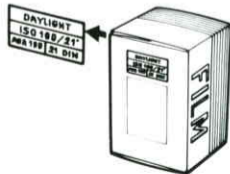
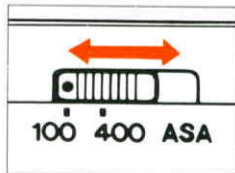

5 Loading the Film

Use color or black and white film in standard 35mm cartridges. Load the film in subdued lighting only.

1. Pull the back cover opening knob ⑳ down to open the back cover ⑮.
2. Insert the film cartridge into the film chamber. Gently press down on the cartridge so that it clicks into place; the back cover opening knob then automatically snaps back to its original position.
3. Pull the film leader across the back so that its tip is aligned with the orange line in the lower right-hand corner of the film chamber. If the film leader extends past the orange line, manually wind the excess film back into the film cartridge. Film will not wind properly if there is too much film slack.
4. Place the film between the film

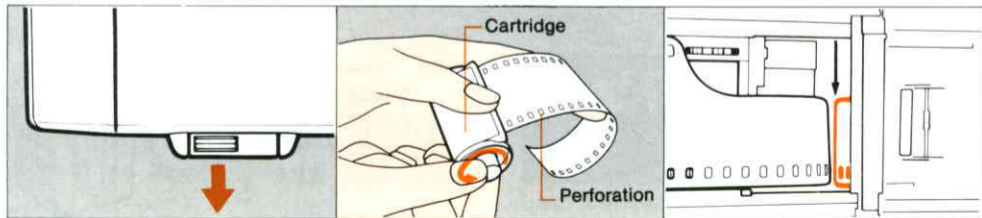

guides, and be sure that the film perforations are engaged with the sprocket teeth. Then close the back cover.

5. Press the shutter button ① until the frame counter ② reaches "1." If the frame counter moves, the film is transporting properly. If it does not move, reload the film.

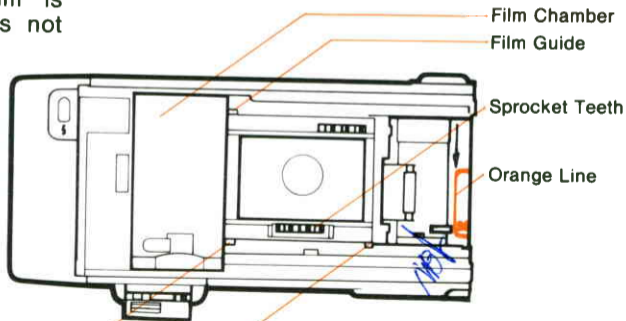
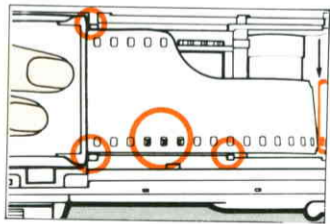

6 Shooting

1. Look through the viewfinder ⑬ and compose the picture so that the main subject is centered in the viewfinder.
2. Gently press the shutter button ① HALFWAY. If the viewfinder lamp blinks rapidly, switch to flash. This lamp warns you when insufficient light may cause overly dark or blurred pictures.
3. Hold the camera in both hands with at least one elbow steadied against your body. Then gently press the shutter button all the way down to take the picture.
4. After you take your finger off the shutter button, the camera's built-in power winder will automatically advance the film to the next frame. As the film advances, the frame counter will also advance one frame. It can count up to 36 frames.

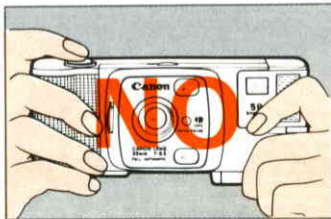

Notes

1. Be sure the flash, lens, and exposure metering window are not blocked by your fingers or hair. With the Snappy 50, also make sure not to cover the autofocus windows.
2. The Snappy 50 is an ACTIVE autofocus system camera, which means the vast majority of subjects will be accurately focused for you. There are a few subjects,

however, for which the autofocus system is not perfectly suited.

These are:

- Glossy subjects (the exterior of a car, glass)
- Subjects with little or no reflectance (black hair, fireworks, blackout curtains)
- Subjects with an object in front of them (an animal in a cage)



Shooting Distance

When taking pictures, make sure your subject is standing within the camera's shooting distance range:

Snappy 50 ... 1.3m (approximately 4-1/2 ft.)
to infinity (∞)

Snappy 20 ... 1.5m (approximately 5 ft.)
to infinity (∞)



Snappy 50 : Keep 1.3m or more apart.



Snappy 20 : Keep 1.5m or more apart.



8 Using the Built-in Flash

Switch to flash photography if the viewfinder lamp blinks rapidly when you press the shutter button halfway. Use of the flash will prevent blurred and overly dark photos.

1. Push the flash switch ⑥ out in the direction of the arrow.
2. Wait for the flash-ready lamp ⑭ to glow; then shoot.

Notes

1. Do not continuously press the shutter button halfway while waiting for the flash-ready lamp to glow; the flash will not charge.
2. If you take the shot before the flash-ready lamp glows, exposure will not be correct.
3. The flash cannot be used to "fill in" shadows in daylight photography.

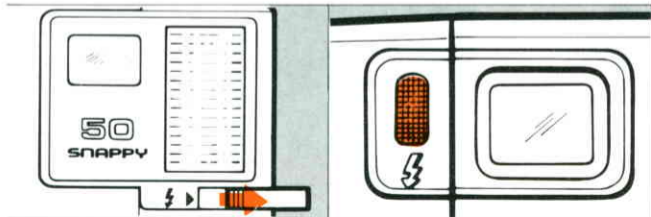



No flash



Using the flash

9 Flash Shooting Distance Range

The shooting distance range within which the built-in flash can be used is:

Snappy 50 1.3–4.5m (approximately 4-1/2–15 ft.) with ISO/ASA 100 or ISO/ASA 400 negative film

Snappy 20 1.5–4.0m (approximately 5–13 ft.) with ISO/ASA 100 negative film
2.7–8.0m (approximately 9–26 ft.) with ISO/ASA 400 negative film



10 Rewinding the Film

You can tell you have come to the end of a roll of film when film advance stops automatically and when the shutter button becomes impossible to push.

IMPORTANT: DO NOT open the back cover until you have rewound the film.

1. To rewind the film, simultaneously press the unlock button ⑱ and slide the film rewind switch ⑱ with your finger in the direction of the arrow. Once the rewind switch has locked

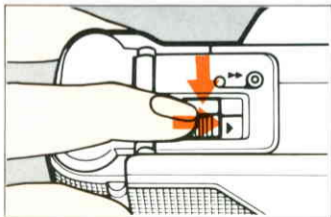

into position, you may withdraw your finger.

2. During rewinding, the frame counter ⑳ counts backwards. When it returns to "S," rewinding stops automatically, and the film rewind switch returns to its original position.
3. Pull the back cover opening knob ㉔ down, open the cover, and remove the film cartridge from the film chamber. Be sure to shield the film from direct sources of light when unloading it.

Neckstrap

Each camera is provided with a built-in neckstrap ¹¹. Simply slide the adjuster ¹² to set the strap to the desired length.

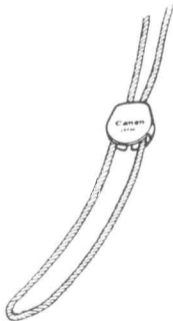

Care of the Camera

1. To clean the camera's glass surfaces, use only a blower brush, cleaning fluid, and tissue made specially for camera lenses. First remove dust with the blower brush. Then apply a few drops of fluid to the tissue (NEVER apply fluid directly to the lens!) and gently wipe the lens in a circular motion. Keep the autofocus and auto exposure windows clean in the same manner. For non-glass surfaces, brush off dust with a blower brush, silicon cloth, or chamois leather. The film compartment also requires gentle cleaning from time to time to remove dust which may scratch the film. To clean the film compart-

ment, use only a blower brush; do not apply any fluids to the rear lens.

2. The best thing you can do for your camera is to use it regularly. If you must store it for a long time, first remove the batteries. Then wrap the camera in a clean, soft cloth and store it in a cool, dry, dust-free area. Always keep the camera out of direct sunlight and very hot spots, such as the trunk or glove compartment of a car. Keep it out of humid and dusty places.
3. Replace the batteries every year; even if they are not used, they will discharge gradually.

SPECIFICATIONS

Type "Snappy 50": 35mm lens-shutter camera with automatic film loading, automatic film advance, power film rewind, automatic exposure, and autofocus.

"Snappy 20": 35mm lens-shutter camera with automatic film loading, automatic film advance, power film rewind, and automatic exposure.

Format 24mm x 36mm

Lens "Snappy 50": Canon 35mm f/3.5.

"Snappy 20": Canon 35mm f/4.5.

Construction: 4 elements in 4 groups.

Lens Shield Open position; shooting is possible. Closed position; shooting is impossible.

Focusing "Snappy 50": Canon ACTIVE autofocus system.

"Snappy 20": Fixed focus.

Shooting Distance Range "Snappy 50": 1.3m (4.3ft.) to infinity (∞).

"Snappy 20": Pan focus, 1.5m (4.9ft.) to infinity (∞).

Shutter Programmed electromagnetic shutter; also serves as diaphragm blades.

Viewfinder Reverse Galilean finder. Mag-

nification: 0.45x. Viewfinder lamp (camera shake warning/battery check LED).

Back Cover Opened by pulling the back cover opening knob.

Film Advance Winding is automatic by pressing and releasing the shutter button for shooting.

Film Rewinding Automatic upon pressing unlock button and pushing film rewind switch. Indicated by frame counter. Film Rewinding stops automatically.

Frame Counter Additive type; automatically resets to "S" by opening back cover. Counts back with film rewind.

Automatic Exposure Coupling Range "Snappy 50": EV 8.6 to EV 15 with ISO/ASA 100.

"Snappy 20": EV 9.3 to EV 15 with ISO/ASA 100.

Film Speed Switch ISO/ASA 100 & 400.

Built-in Flash Switches to flash photography by sliding the flash switch.

Guide Number 11 (ISO/ASA 100-m)

Flash Shooting Distance "Snappy 50": 1.3 to 4.5m (app. 4-1/2 to 15ft.) with ISO/

ASA 100 or ISO/ASA 400.

"Snappy 20": 1.5m to 4.0m (app. 5 to 13ft.) with ISO/ASA 100. 2.7 to 8m (app. 9 to 26ft.) with ISO/ASA 400.

Flash Recycling Time Less than eight seconds (interval between firing of flash and re-lighting of flash-ready lamp) with new alkaline batteries.

Battery Life Using new alkaline batteries at normal temperatures: Without flash, approximately 30 rolls of 36 exposure film. Using flash for each exposure, approximately 5 rolls of 36 exposure film.

Power Source Two size-AA 1.5 V alkaline or carbon-zinc batteries. (Ni-Cd batteries cannot be used.)

Dimensions 148.2 (W) x 58.3 (H) x 43.6 (D) mm (5-5/16" x 2-5/16" x 1-11/16")

Weight "Snappy 50": 245g (8-5/8 oz.) without batteries.

"Snappy 20": 235g (8-5/16 oz.) without batteries.

Subject to change without notice.

NOMENCLATURE

